

FEATURES

- Requires no external components
- Supply voltage range covers from 2.7V to 5.5V
- Measures temperatures from -55°C to $+125^{\circ}\text{C}$ in 0.5°C increments. Fahrenheit equivalent is -67°F to $+257^{\circ}\text{F}$ in 0.9°F increments
- Temperature is read as a 9-bit value
- Converts temperature to digital word in 1 second (max)
- Thermostatic settings are user-definable and non-volatile
- Data is read from/written via a 3-wire serial interface (CLK, DQ, $\overline{\text{RST}}$)
- Applications include thermostatic controls, industrial systems, consumer products, thermometers, or any thermally sensitive system
- 8-pin SOIC (208 mil) package

PIN ASSIGNMENT

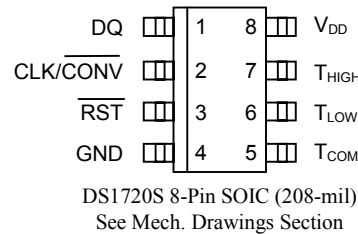

PIN DESCRIPTION

DQ	– 3-Wire Input/Output
CLK/ $\overline{\text{CONV}}$	– 3-Wire Clock Input and Stand-alone Convert Input
$\overline{\text{RST}}$	– 3-Wire Reset Input
GND	– Ground
T_{HIGH}	– High Temperature Trigger
T_{LOW}	– Low Temperature Trigger
T_{COM}	– High/Low Combination Trigger
V_{DD}	– Power Supply Voltage (3V-5V)

DESCRIPTION

The DS1720 Digital Thermometer and Thermostat provides 9-bit temperature readings which indicate the temperature of the device. With three thermal alarm out-puts, the DS1720 can also act as a thermostat. T_{HIGH} is driven high if the DS1720's temperature is greater than or equal to a user-defined temperature TH. T_{LOW} is driven high if the DS1720's temperature is less than or equal to a user-defined temperature TL. T_{COM} is driven high when the temperature exceeds TH and stays high until the temperature falls below that of TL.

User-defined temperature settings are stored in non-volatile memory, so parts can be programmed prior to insertion in a system, as well as used in stand-alone applications without a CPU. Temperature settings and temperature readings are all communicated to/from the DS1720 over a simple 3-wire interface.

OPERATION—MEASURING TEMPERATURE

A block diagram of the DS1720 is shown in Figure 1. The DS1720 measures temperatures through the use of an on-board proprietary temperature measurement technique. A block diagram of the temperature measurement circuitry is shown in Figure 2.

The DS1720 measures temperature by counting the number of clock cycles that an oscillator with a low temperature coefficient goes through during a gate period determined by a high temperature coefficient oscillator. The counter is preset with a base count that corresponds to -55°C . If the counter reaches zero before the gate period is over, the temperature register, which is also preset to the -55°C value, is incremented, indicating that the temperature is higher than -55°C . At the same time, the counter is then preset with a value determined by the slope accumulator circuitry. This circuitry is needed to compensate for the parabolic behavior of the oscillators over temperature. The counter is then clocked again until it reaches zero. If the gate period is still not finished, then this process repeats.

The slope accumulator is used to compensate for the nonlinear behavior of the oscillators over temperature, yielding a high resolution temperature measurement. This is done by changing the number of counts necessary for the counter to go through for each incremental degree in temperature. To obtain the desired resolution, therefore, both the value of the counter and the number of counts per degree C (the value of the slope accumulator) at a given temperature must be known.

DS1720 FUNCTIONAL BLOCK DIAGRAM Figure 1

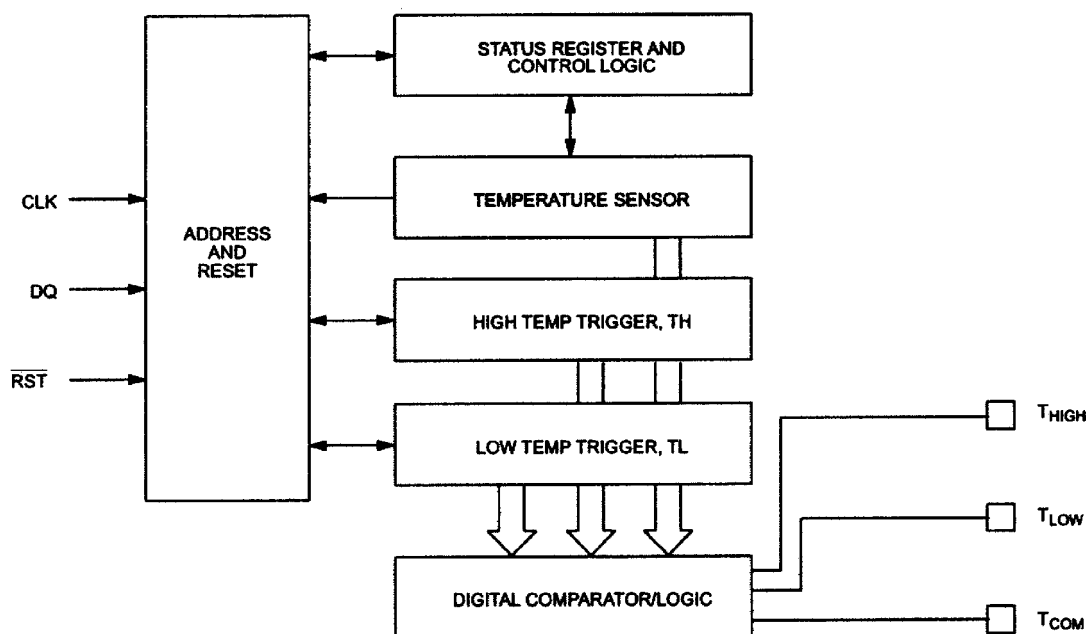

TEMPERATURE MEASURING CIRCUITRY Figure 2

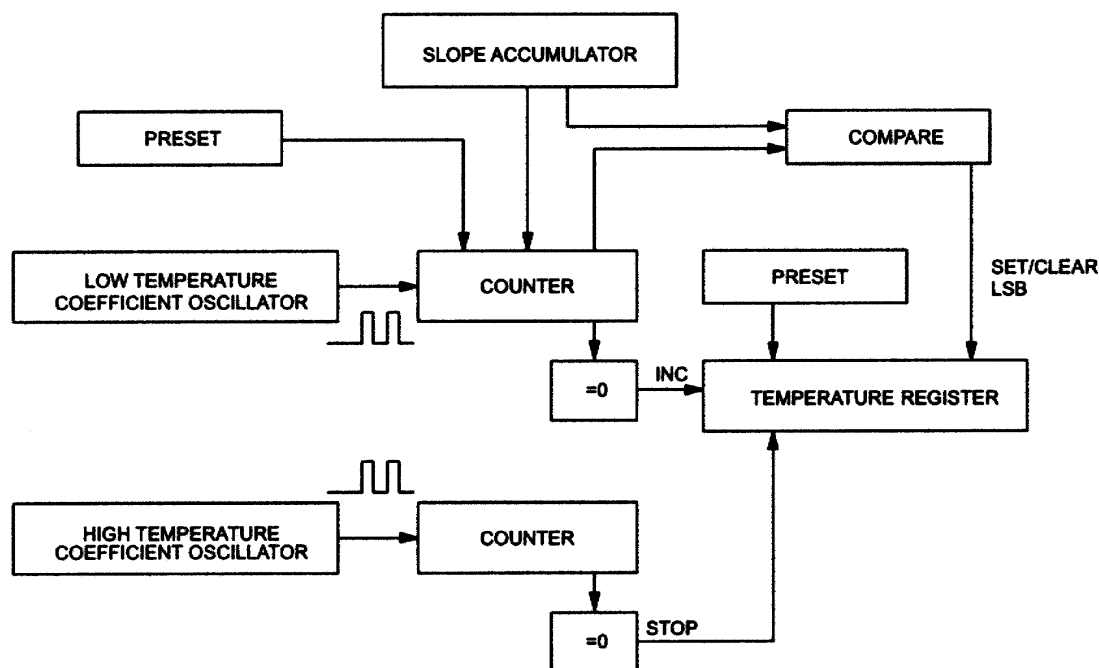

This calculation is done inside the DS1720 to provide 0.5°C resolution. The temperature reading is provided in a 9-bit, two's complement reading by issuing a READ TEMPERATURE command. Table 1 describes the exact relationship of output data to measured temperature. The data is transmitted serially through the 3-wire serial interface, LSB first. The DS1720 can measure temperature over the range of -55°C to +125°C in 0.5°C increments. For Fahrenheit usage, a lookup table or conversion factor must be used.

TEMPERATURE/DATA RELATIONSHIPS Table 1

TEMP	DIGITAL OUTPUT (Binary)	DIGITAL OUTPUT (Hex)
+85°C	0 10101010	00AA
+25°C	0 00110010	0032h
+½°C	0 00000001	0001h
+0°C	0 00000000	0000h
-½°C	1 11111111	01FFh
-25°C	1 11001110	01CEh

Since data is transmitted over the 3-wire bus LSB first, temperature data can be written to/read from the DS1720 as either a 9-bit word (taking $\overline{\text{RST}}$ low after the 9th (MSB) bit), or as two transfers of 8-bit words, with the most significant 7 bits being ignored or set to zero, as illustrated in Table 1. After the MSB, the DS1720 will output 0s.

Note that temperature is represented in the DS1720 in terms of a ½°C LSB, yielding the following 9-bit format:

MSB								LSB							
X	X	X	X	X	X	X	1	1	1	0	0	1	1	1	0

$$T = -25^{\circ}\text{C}$$

Higher resolutions may be obtained by reading the temperature, and truncating the 0.5°C bit (the LSB) from the read value. This value is TEMP_READ. The value left in the counter may then be read by issuing a READ COUNTER command. This value is the count remaining (COUNT_REMAIN) after the gate period has ceased. By loading the value of the slope accumulator into the count register (using the READ SLOPE command), this value may then be read, yielding the number of counts per degree C (COUNT_PER_C) at that temperature. The actual temperature may then be calculated by the user using the following:

$$\text{TEMPERATURE} = \text{TEMP_READ} - 0.25 + \frac{(\text{COUNT_PER_C} - \text{COUNT_REMAIN})}{\text{COUNT_PER_C}}$$

DETAILED PIN DESCRIPTION Table 2

PIN	SYMBOL	DESCRIPTION
1	DQ	Data Input/Output pin for 3-wire communication port.
2	CLK/ $\overline{\text{CONV}}$	Clock input pin for 3-wire communication port. When the DS1720 is used in a stand-alone application with no 3-wire port, this pin can be used as a convert pin. Temperature conversion will begin on the falling edge of $\overline{\text{CONV}}$.
3	$\overline{\text{RST}}$	Reset input pin for 3-wire communication port.
4	GND	Ground pin.
5	T _{COM}	High/Low Combination Trigger. Goes high when temperature exceeds TH; will reset to low when temperature falls below TL.
6	T _{LOW}	Low Temperature Trigger. Goes high when temperature falls below TL.
7	T _{HIGH}	High Temperature Trigger. Goes high when temperature exceeds TH.
8	V _{DD}	Supply Voltage. 2.7V – 5.5V input power pin.

OPERATION—THERMOSTAT CONTROLS

Three thermally triggered outputs, T_{HIGH}, T_{LOW}, and T_{COM}, are provided to allow the DS1720 to be used as a thermostat, as shown in Figure 3. When the DS1720's temperature meets or exceeds the value stored in the high temperature trip register, the output T_{HIGH} becomes active (high) and remains active until the DS1720's measured temperature becomes less than the stored value in the high temperature register, TH. The T_{HIGH} output can be used to indicate that a high temperature tolerance boundary has been met or exceeded, or as part of a closed loop system can be used to activate a cooling system and to deactivate it when the system temperature returns to tolerance.

The T_{LOW} output functions similarly to the T_{HIGH} output. When the DS1720's measured temperature equals or falls below the value stored in the low temperature register, the T_{LOW} output becomes active. T_{LOW} remains active until the DS1720's temperature becomes greater than the value stored in the low temperature register, TL. The T_{LOW} output can be used to indicate that a low temperature tolerance boundary has been met or exceeded, or as part of a closed loop system, can be used to activate a heating system and to deactivate it when the system temperature returns to tolerance.

The T_{COM} output goes high when the measured temperature meets or exceeds TH, and will stay high until the temperature equals or falls below TL. In this way, any amount of hysteresis can be obtained.

THERMOSTAT OUTPUT OPERATION Figure 3

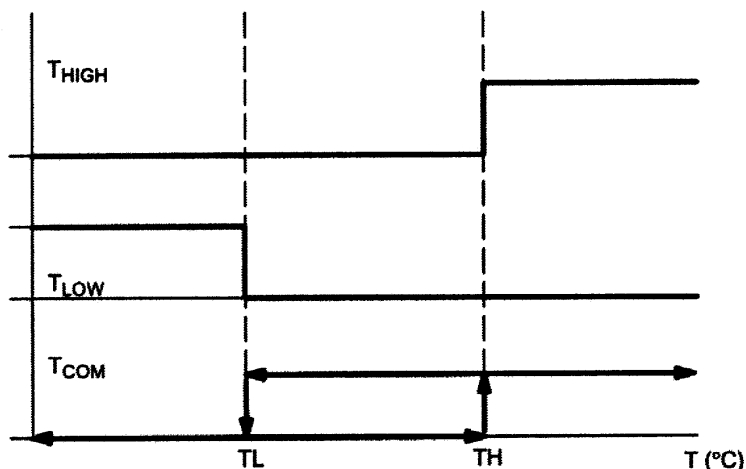

OPERATION AND CONTROL

The DS1720 must have temperature settings resident in the TH and TL registers for thermostatic operation. A configuration/status register is also used to determine the method of operation that the DS1720 will use in a particular application, as well as indicating the status of the temperature conversion operation. The configuration register is defined as follows:

CONFIGURATION/STATUS REGISTER

DONE	THF	TLF	NVB	1	0	CPU	1SHOT
------	-----	-----	-----	---	---	-----	-------

where

DONE = Conversion Done bit. 1=conversion complete, 0=conversion in progress.

THF = Temperature High Flag. This bit will be set to 1 when the temperature is greater than or equal to the value of TH. It will remain 1 until reset by writing 0 into this location or by removing power from the device. This feature provides a method of determining if the DS1720 has ever been subjected to temperatures above TH while power has been applied.

TLF = Temperature Low Flag. This bit will be set to 1 when the temperature is less than or equal to the value of TL. It will remain 1 until reset by writing 0 into this location or by removing power from the device. This feature provides a method of determining if the DS1720 has ever been subjected to temperatures below TL while power has been applied.

NVB = Nonvolatile Memory Busy Flag. 1=write to an E^2 memory cell in progress. 0=nonvolatile memory is not busy. A copy to E^2 may take up to 10 ms.

CPU = CPU use bit. If CPU=0, the CLK/ $\overline{\text{CONV}}$ pin acts as a conversion start control, when $\overline{\text{RST}}$ is low. If CPU is 1, the DS1720 will be used with a CPU communicating to it over the 3-wire port, and the operation of the CLK/ $\overline{\text{CONV}}$ pin is as a normal clock in concert with DQ and $\overline{\text{RST}}$. This bit is stored in nonvolatile E^2 memory, capable of at least 50,000 writes. The DS1720 is shipped with CPU=0.

1SHOT = One-Shot Mode. If 1SHOT is 1, the DS1720 will perform one temperature conversion upon reception of the Start Convert T protocol. If 1SHOT is 0, the DS1720 will continuously perform temperature conversion. This bit is stored in nonvolatile E^2 memory, capable of at least 50,000 writes. The DS1720 is shipped with 1SHOT=0.

For typical thermostat operation, the DS1720 will operate in continuous mode. However, for applications where only one reading is needed at certain times, and to conserve power, the one-shot mode may be used. Note that the thermostat outputs (T_{HIGH} , T_{LOW} , T_{COM}) will remain in the state they were in after the last valid temperature conversion cycle when operating in one-shot mode.

OPERATION IN STAND-ALONE MODE

In applications where the DS1720 is used as a simple thermostat, no CPU is required. Since the temperature limits are nonvolatile, the DS1720 can be programmed prior to insertion in the system. In order to facilitate operation without a CPU, the CLK/ $\overline{\text{CONV}}$ pin (pin 2) can be used to initiate conversions. Note that the CPU bit must be set to 0 in the configuration register to use this mode of operation. Whether CPU=0 or 1, the 3-wire port is active. Setting CPU=1 disables the stand-alone mode.

To use the CLK/ $\overline{\text{CONV}}$ pin to initiate conversions, $\overline{\text{RST}}$ must be low and CLK/ $\overline{\text{CONV}}$ must be high. If CLK/ $\overline{\text{CONV}}$ is driven low and then brought high in less than 10 ms, one temperature conversion will be performed and then the DS1720 will return to an idle state. If CLK/ $\overline{\text{CONV}}$ is driven low and remains low, continuous conversions will take place until CLK/ $\overline{\text{CONV}}$ is brought high again. With the CPU bit set to 0, the CLK/ $\overline{\text{CONV}}$ will override the 1-shot bit if it is equal to 1. This means that even if the part is set for one-shot mode, driving CLK/ $\overline{\text{CONV}}$ low will initiate conversions.

3-WIRE COMMUNICATIONS

The 3-wire bus is comprised of three signals. These are the $\overline{\text{RST}}$ (reset) signal, the CLK (clock) signal, and the DQ (data) signal. All data transfers are initiated by driving the $\overline{\text{RST}}$ input high. Driving the $\overline{\text{RST}}$ input low terminates communication. (See Figures 4 and 5). A clock cycle is a sequence of a falling edge followed by a rising edge. For data inputs, the data must be valid during the rising edge of a clock cycle. Data bits are output on the falling edge of the clock, and remain valid through the rising edge.

When reading data from the DS1720, the DQ pin goes to a high impedance state while the clock is high. Taking $\overline{\text{RST}}$ low will terminate any communication and cause the DQ pin to go to a high impedance state.

Data over the 3-wire interface is communicated LSB first. The command set for the 3-wire interface as shown in Table 3 is as follows; only these protocols should be written to the DS1720, as writing other protocols to the device may result in permanent damage to the part.

Read Temperature [AAh]

This command reads the contents of the register which contains the last temperature conversion result. The next nine clock cycles will output the contents of this register.

Write TH [01h]

This command writes to the TH (HIGH TEMPERATURE) register. After issuing this command, the next nine clock cycles clock in the 9-bit temperature limit which will set the threshold for operation of the T_{HIGH} output.

Write TL [02h]

This command writes to the TL (LOW TEMPERATURE) register. After issuing this command, the next nine clock cycles clock in the 9-bit temperature limit which will set the threshold for operation of the T_{LOW} output.

Read TH [A1h]

This command reads the value of the TH (HIGH TEMPERATURE) register. After issuing this command, the next nine clock cycles clock out the 9-bit temperature limit which sets the threshold for operation of the T_{HIGH} output.

Read TL [A2h]

This command reads the value of the TL (LOW TEMPERATURE) register. After issuing this command, the next nine clock cycles clock out the 9-bit temperature limit which sets the threshold for operation of the T_{LOW} output.

Read Counter [A0h]

This command reads the value of the counter byte. The next nine clock cycles will output the contents of this register.

Read Slope [A9h]

This command reads the value of the slope counter byte from the DS1720. The next nine clock cycles will output the contents of this register.

Start Convert T [EEh]

This command begins a temperature conversion. No further data is required. In one-shot mode, the temperature conversion will be performed and then the DS1720 will remain idle. In continuous mode, this command will initiate continuous conversions.

Stop Convert T [22h]

This command stops temperature conversion. No further data is required. This command may be used to halt a DS1720 in continuous conversion mode. After issuing this command, the current temperature measurement will be completed, and then the DS1720 will remain idle until a Start Convert T is issued to resume continuous operation.

Write Config [0Ch]

This command writes to the configuration register. After issuing this command, the next eight clock cycles clock in the value of the configuration register.

Read Config [ACh]

This command reads the value in the configuration register. After issuing this command, the next eight clock cycles output the value of the configuration register.

DS1720 COMMAND SET Table 3

INSTRUCTION	DESCRIPTION	PROTOCOL	3-WIRE BUS DATA AFTER ISSUING PROTOCOL	NOTES
TEMPERATURE CONVERSION COMMANDS				
Read Temperature	Temperature Reads last converted temperature value from temperature register	AAh	<read data>	
Read Counter	Reads value of count remaining from counter	A0h	<read data>	
Read Slope	Reads value of the slope accumulator	A9h	<read data>	
Start Convert T	Initiates temperature conversion	EEh	Idle	1
Stop Convert T	Halts temperature conversion	22h	Idle	1
THERMOSTAT COMMANDS				
Write TH	Writes high temperature limit value into TH register	01h	<write data>	2
Write TL	Writes low temperature limit value into TL register	02h	<write data>	2
Read TH	Reads stored value of high temperature limit from TH register	A1h	<read data>	2
Read TL	Reads stored value of low temperature limit from TL register	A2h	<read data>	2
Write Config	Writes configuration data to configuration register	0Ch	<write data>	2
Read Config	Reads configuration data from configuration register	ACh	<read data>	2

NOTES:

1. In continuous conversion mode, a Stop Convert T command will halt continuous conversion. To restart, the Start Convert T command must be issued. In one-shot mode, a Start Convert T command must be issued for every temperature reading desired.
2. Writing to the E² typically requires 10 ms at room temperature. After issuing a write command, no further writes should be requested for at least 10 ms.

FUNCTION EXAMPLE

Example: CPU sets up DS1720 for continuous conversion and thermostatic function.

CPU MODE	DS1720 MODE (3-WIRE)	DATA (LSB FIRST)	COMMENTS
TX	RX	0Ch	TCPU issues Write Config command
TX	RX	00h	CPU sets DS1720 up for continuous conversion
TX	RX	Toggle $\overline{\text{RST}}$	CPU issues Reset to DS1720
TX	RX	01h	CPU issues Write TH command
TX	RX	0050h	CPU sends data for TH limit of +40°C
TX	RX	Toggle $\overline{\text{RST}}$	CPU issues Reset to DS1720
TX	RX	02h	CPU issues Write TL command
TX	RX	0014h	CPU sends data for TL limit of +10°C
TX	RX	Toggle $\overline{\text{RST}}$	CPU issues Reset to DS1720
TX	RX	A1h	CPU issues Read TH command
RX	TX	0050h	DS1720 sends back stored value of TH for CPU to verify
TX	RX	Toggle $\overline{\text{RST}}$	CPU issues Reset to DS1720
TX	RX	A2h	CPU issues Read TL command
RX	TX	0014h	DS1720 sends back stored value of TL for CPU to verify
TX	RX	Toggle $\overline{\text{RST}}$	RST CPU issues Reset to DS1720
TX	RX	EEh	CPU issues Start Convert T command
TX	RX	Toggle $\overline{\text{RST}}$	CPU issues Reset to DS1720

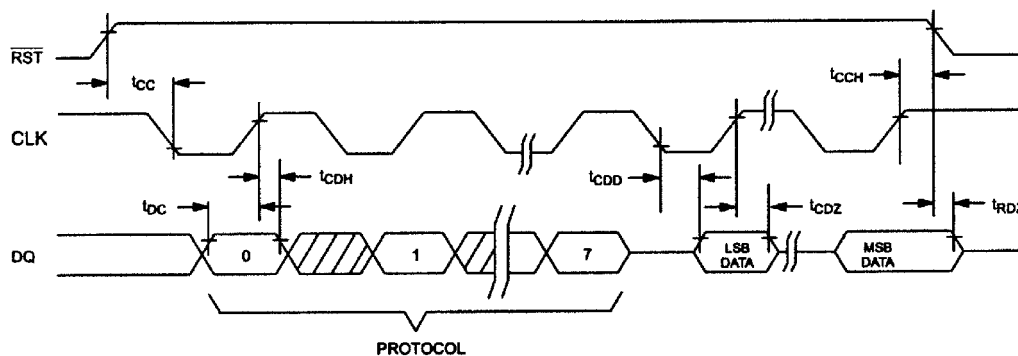
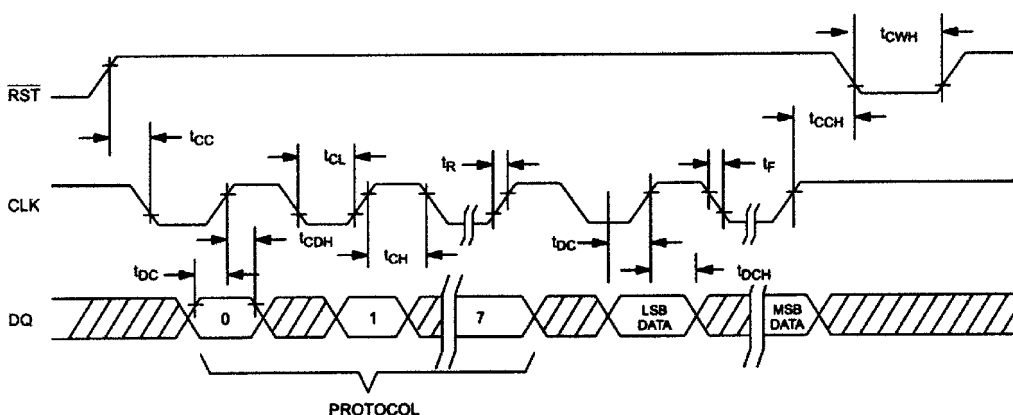
READ DATA TRANSFER Figure 4**WRITE DATA TRANSFER Figure 5****RELATED APPLICATION NOTES**

The following Application Notes can be applied to the DS1720. These notes can be obtained from the Dallas Semiconductor "Application Note Book", via our web-site at <http://www.dalsemi.com/>, or through our faxback service at (972) 371-4441.

Application Note 67: "Applying and Using the DS1620 in Temperature Control Applications"

Application Note 85: "Interfacing the DS1620 to the Motorola SPI Bus"

Application Note 105: "High Resolution Temperature Measurement with Dallas Direct-to-Digital Temperature Sensors"

Sample DS1720 subroutines that can be used in conjunction with AN105 can be downloaded from the web-site or our Anonymous FTP Site.

ABSOLUTE MAXIMUM RATINGS*

Voltage on Any Pin Relative to Ground	-0.5V to +7.0V
Operating Temperature	-55°C to +125°C
Storage Temperature	-55°C to +125°C
Soldering Temperature	260°C for 10 seconds

*This is a stress rating only and functional operation of the device at these or any other conditions above those indicated in the operation sections of this specification is not implied. Exposure to absolute maximum rating conditions for extended periods of time may affect reliability.

The Dallas Semiconductor DS1720 is built to the highest quality standards and manufactured for long term reliability. All Dallas Semiconductor devices are made using the same quality materials and manufacturing methods. However, the DS1720 is not exposed to environmental stresses, such as burn-in, that some industrial applications require. For specific reliability information on this product, please contact the factory in Dallas at (972) 371-4448.

RECOMMENDED DC OPERATING CONDITIONS

PARAMETER	SYMBOL	MIN	TYP	MAX	UNITS	NOTES
Supply	V_{DD}	2.7		5.5	V	1
Logic 1	V_{IH}	2.0		$V_{CC}+0.3$	V	1
Logic 0	V_{IL}	-0.3		+0.6	V	1

DC ELECTRICAL CHARACTERISTICS (-55°C to +125°C; $V_{DD}=2.7V$ to 5.5V)

PARAMETER	SYMBOL	CONDITION	MIN	MAX	UNITS	NOTES
Thermometer Error	T_{ERR}	0°C to 85°C -55°C to +125°C		±2.5	°C	10,11 See Typical Curve
Logic 0 Output	V_{OL}			0.4	V	3
Logic 1 Output	V_{OH}		2.4		V	2
Input Resistance	R_I	\overline{RST} to GND DQ, CLK to V_{DD}		2 2	MΩ MΩ	
Active Supply Current	I_{CC}	0°C to +70°C		1	mA	4,5
Standby Supply Current	I_{STBY}	0°C to +70°C		1	μA	4,5

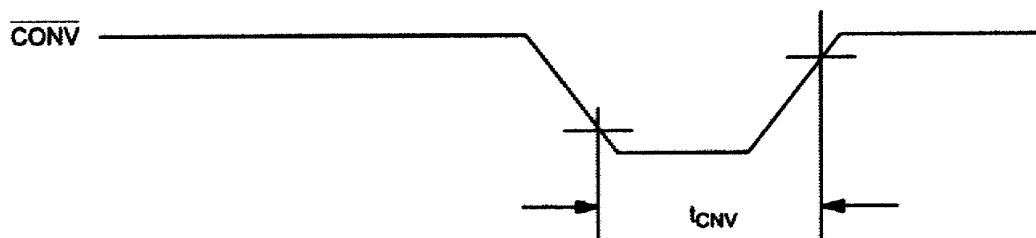
SINGLE CONVERT TIMING DIAGRAM (STAND-ALONE MODE)

AC ELECTRICAL CHARACTERISTICS (-55°C to +125°C; $V_{DD}=2.7V$ to 5.5V)

PARAMETER	SYMBOL	MIN	TYP	MAX	UNITS	NOTES
Temperature Conversion Time	T_{TC}		400	1000	ms	
Data to CLK Setup	t_{DC}	35			ns	6
CLK to Data Hold	t_{CDH}	40			ns	6
CLK to Data Delay	t_{CDD}			100	ns	6,7,8
CLK Low Time	t_{CL}	285			ns	6
CLK High Time	t_{CH}	285			ns	6
CLK Frequency	t_{CLK}	DC		1.75	MHz	6
CLK Rise and Fall	t_R, t_F			500	ns	
\overline{RST} to CLK Setup	t_{CC}	100			ns	6
CLK to \overline{RST} Hold	t_{CCH}	40			ns	6
\overline{RST} Inactive Time	t_{CWH}	125			ns	6,9
CLK High to I/O High-Z	t_{CDZ}			50	ns	6
\overline{RST} Low to I/O High-Z	t_{RDZ}			50	ns	6
Convert Pulse Width	t_{CNV}	250 ns		500 ms		
NV Write Cycle Time	t_{WR}		10	50	ms	12

AC ELECTRICAL CHARACTERISTICS (-55°C to +125°C; $V_{DD}=2.7V$ to 5.5V)

PARAMETER	SYMBOL	MIN	TYP	MAX	UNITS	NOTES
Input Capacitance	C_I		5		pF	
I/O Capacitance	$C_{I/O}$		10		pF	

NOTES:

- All voltages are referenced to ground.
- Logic one voltages are specified at a source current of 1 mA.
- Logic zero voltages are specified at a sink current of 4 mA.
- I_{CC} specified with DQ pin open and CLK pin at V_{DD} .
- I_{CC} specified with V_{CC} at 3.3V and $\overline{RST} = GND$.
- Measured at $V_{IH} = 2.0V$ or $V_{IL} = 0.6V$.
- Measured at $V_{OH} = 2.4V$ or $V_{OL} = 0.4V$.
- Load capacitance = 50 pF.
- t_{CWH} must be 10 ms minimum following any write command that involves the E² memory.
- See typical curve for specification limits outside 0°C to 85°C range.
- Thermometer error reflects temperature accuracy as tested during calibration.
- Writing to the nonvolatile memory should only take place in the 0°C to 70°C temperature range.

DS1720 TYPICAL THERMOMETER ERROR

